



# SIRIO

frappè  
drink mixers



- Famiglia completa di macchine per il frappè caratterizzato da linee morbide e precise. Studiati per un utilizzo professionale e severo nel rispetto delle norme di sicurezza europee e nordamericane.
- Corpo macchina bianco o cromato, colonna in alluminio estruso e base in pressofusione per una ottima stabilità della macchina, il tutto privo di angoli e giunzioni per facilitare la pulizia.
- Disponibile nella versione da banco 1 o 2 bicchieri o a parete.
- Bicchiere da 550 cc in Tritan (BPA Free) trasparente o a richiesta in acciaio inox.
- Bicchiere da 900 cc in acciaio inox su versione da 120 watt.
- Motore potente e ventilato per una maggiore durata.
- Versione con 3 fruste in alluminio e acciaio per la preparazione di frappè e sorbetti o con disco appositamente studiato per il caffè shakerato o per montare il prodotto in lavorazione.
- Microinterruttore di sicurezza sul bicchiere (opzionale per paesi extra UE).
- Variatore di velocità a richiesta.

- *A complete line of drink mixers with a soft design. Designed to commercial use, they meet all European and North-American safety requirements.*
- *White or chrome head, aluminium stem and die casting base for a perfect stability, no edges or seams for easier cleaning.*
- *Countertop (1 or 2 cups) or wall unit versions available.*
- *Transparent 550 cc Tritan (BPA Free) cup or stainless steel cup on request.*
- *900 cc stainless steel cup on 120 W version.*
- *Powerful ventilated motor for a longer life.*
- *Spindle with three aluminium and s/steel agitators for preparing milkshakes and drinks, or with a special round agitator for frozen coffees or for creamier results.*
- *Safety microswitch on the cup support (optional for non UE countries).*
- *Speed control on request.*



SIRIO 1 VV



SIRIO 1 VV - 120W 900CC









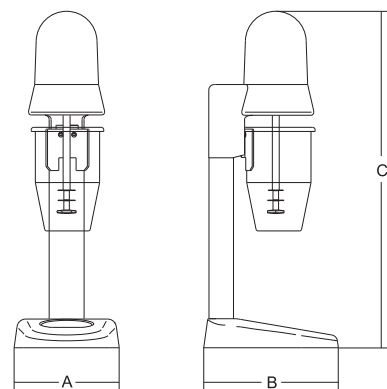



SIRIO 2 VV



SIRIO 2

**SIRIO CAFFÈ**Particolare fruste Sirio 120W  
Sirio 120W agitatorsOpzionale: Anello portabicchieri usa e getta  
Optional: ring for paper cups

										
	watt/Hp		r.p.m.	lit	mm	mm	mm	kg	mm	kg
<b>Sirio 1</b>	100/0.14	1ph	14.000	0.55	150	195	485	2.5	210x250x520	3.5
<b>Sirio 2</b>	100+100/0.14+0.14	1ph	14.000	0.55x2	300	195	485	5	370x260x530	6.5
<b>Sirio 1P</b>	100/0.14	1ph	14.000	0.55	110	150	360	2	190x240x510	4
<b>Sirio 1 VV</b>	100/0.14	1ph	4.000÷14.000	0.55	150	195	485	2.5	210x250x520	3.5
<b>Sirio 2 VV</b>	100+100/0.14+0.14	1ph	4.000÷14.000	0.55x2	300	195	485	5	370x260x530	6.5
<b>Sirio 1P VV</b>	100/0.14	1ph	4.000÷14.000	0.55	110	150	360	2	190x240x510	4
<b>Sirio 1 - 120W 900cc</b>	120/0.16	1ph	14.000	0.9	150	195	530	3	210x250x560	4.5
<b>Sirio 1 VV - 120W 900cc</b>	120/0.16	1ph	4.000-14.000	0.9	150	195	530	3	210x250x560	4.5
<b>Sirio 2 - 120W 900cc</b>	120+120/0.16+0.16	1ph	14.000	0.9x2	300	195	530	6	360x250x560	7
<b>Sirio 2 VV - 120W 900cc</b>	120+120/0.16+0.16	1ph	4.000-14.000	0.9x2	300	195	530	6	360x250x560	7

**SIRIO 1****SIRIO 1P VV****SIRIO 1P**